

IEG1-25715-1

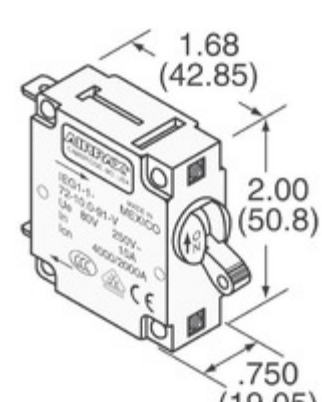

Obrázky jsou pouze orientační.
Podrobné informace o produktu naleznete v části Technické údaje produktu.

Koupit IEG1-25715-1 s důvěrou od Component-World.HK, 1 rok záruka



Part Number: [IEG1-25715-1](#)

Výrobce: [Sensata Technologies, Airpax](#)

Popis: CIR BRKR MAG-HYDR LEVER

Datový list: [IEG, IUG, JEG, CEG, LEG Series Datasheet](#)

RoHS Status: Bez olova / V souladu RoHS

Ship From: Hong Kong

Shipment Way: DHL/Fedex/TNT/UPS/EMS

[Request For Quotation](#)







PARAMETR PRODUKTU

Part Number	IEG1-25715-1	Výrobce	Sensata Technologies, Airpax
Popis	CIR BRKR MAG-HYDR LEVER	Stav volného vedení / RoHS	Bez olova / V souladu RoHS
Dostupné množství	3471 pcs	Datový list	IAG,IUG,JEG,CEG,LEG Series Datasheet
Kategorie	Ochrana obvodu	Série	IEG
Počet póů	1	Typ montáže	Panel Mount
Úroveň citlivosti na vlhkost (MSL)	1 (Unlimited)	Výrobní standardní doba výroby	6 Weeks
Stav volného vedení / RoHS	Lead free / RoHS Compliant	Osvětlení napětí (nominální)	-
Osvětlení	-	Jmenovitá hodnota proudu	-
Breaker Typ	Magnetic (Hydraulic Delay)	Pohon Type	Lever

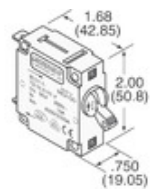
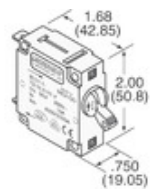
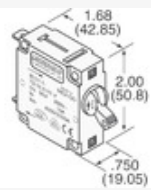
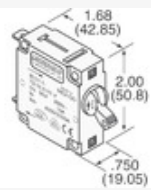
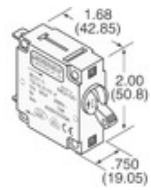
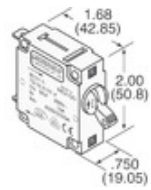
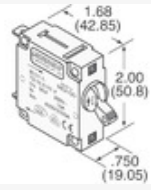
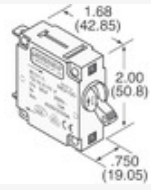
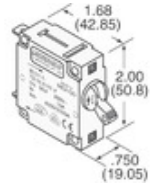
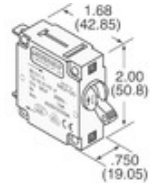
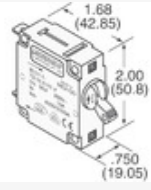
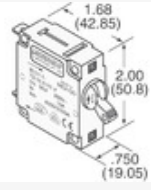
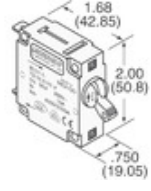
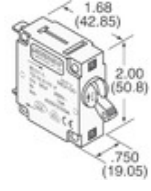
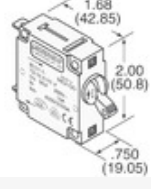
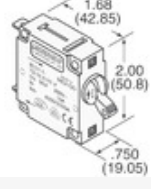
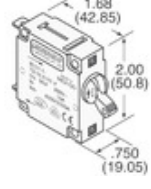
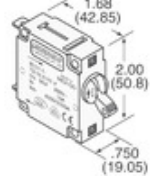
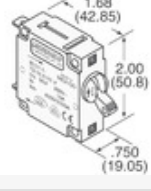
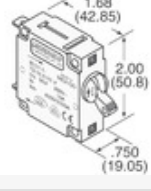
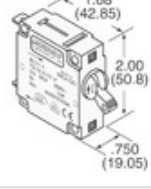
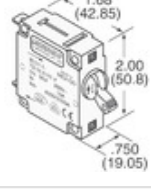
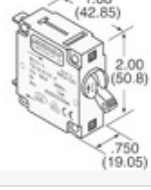
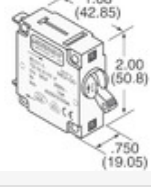
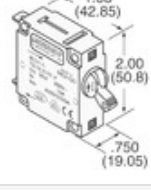
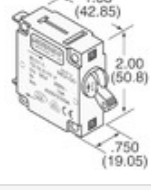
Component-World.com je spolehlivý distributor elektronických součástek. Specializujeme se na všechny elektronické komponenty řady Sensata Technologies, Airpax. Máme 3471 kusy Sensata Technologies, Airpax IEG1-25715-1 na skladě dostupných. Vyžádejte si citát z distributora součástí elektroniky na Component-World.com, náš prodejní tým vás bude kontaktovat do 24 hodin.

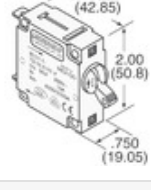
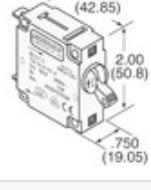
RFQ Email: info@Components-World.com

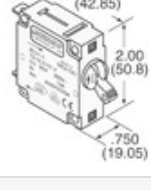
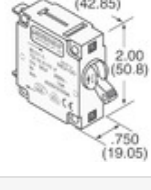
SOUVISEJÍCÍ PRODUKTY

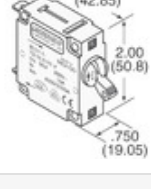
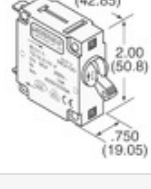
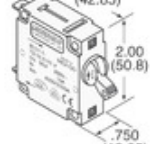
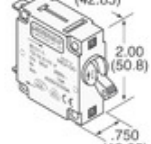
	Část#: IEG1-29230-1-V	Výrobci: Sensata Technologies, Airpax	Dotaz
	Popis: CIR BRKR MAG-HYDR LEVER		
	Část#: IEG1-1REG4-35887-15-V	Výrobci: Sensata Technologies, Airpax	Dotaz
	Popis: CIR BRKR MAG-HYDR LEVER		
	Část#: IEG1-1REC5-69-1.00-31-V	Výrobci: Sensata Technologies, Airpax	Dotaz
	Popis: CIR BRKR MAG-HYDR		
	Část#: IEG1-30624-1-V	Výrobci: Sensata Technologies, Airpax	Dotaz
	Popis: CIR BRKR MAG-HYDR LEVER		
	Část#: IEG1-21478-2	Výrobci: Sensata Technologies, Airpax	Dotaz
	Popis: CIR BRKR MAG-HYDR LEVER		
	Část#: IEG1-26078-1-V	Výrobci: Sensata Technologies, Airpax	Dotaz
	Popis: CIR BRKR MAG-HYDR LEVER		
	Část#: IEG1-30624-2-V	Výrobci: Sensata Technologies, Airpax	Dotaz
	Popis: CIR BRKR MAG-HYDR LEVER		
	Část#: IEG1-29628-1-V	Výrobci: Sensata Technologies, Airpax	Dotaz
	Popis: CIR BRKR MAG-HYDR LEVER		
	Část#: IEG1-30021-1-V	Výrobci: Sensata Technologies, Airpax	Dotaz
	Popis: CIR BRKR MAG-HYDR LEVER		
	Část#: IEG1-1REC5-69-100-21-V	Výrobci: Sensata Technologies, Airpax	Dotaz
	Popis: CIR BRKR MAG-HYDR		
	Část#: IEG1-1REG4-51-2.00-A-01-V	Výrobci: Sensata Technologies, Airpax	Dotaz
	Popis: CIR BRKR MAG-HYDR		
	Část#: IEG1-29230-2-V	Výrobci: Sensata Technologies, Airpax	Dotaz
	Popis: CIR BRKR MAG-HYDR LEVER		
	Část#: IEG1-30240-15-V	Výrobci: Sensata Technologies, Airpax	Dotaz
	Popis: CIR BRKR MAG-HYDR LEVER		
	Část#: IEG1-1REC5-69-500-31-UV	Výrobci: Sensata Technologies, Airpax	Dotaz
	Popis: CIR BRKR MAG-HYDR 500MA LEVER		
	Část#: IEG1-29230-3-V	Výrobci: Sensata Technologies, Airpax	Dotaz
	Popis: CIR BRKR MAG-HYDR LEVER		
	Část#: IEG1-1REG4-51-10.0-A-01-V	Výrobci: Sensata Technologies, Airpax	Dotaz
	Popis: CIR BRKR MAG-HYDR		
	Část#: IEG1-1REG4-26371-6-V	Výrobci: Sensata Technologies, Airpax	Dotaz
	Popis: CIR BRKR MAG-HYDR LEVER		
	Část#: IEG1-26078-5-V	Výrobci: Sensata Technologies, Airpax	Dotaz
	Popis: CIR BRKR MAG-HYDR LEVER		
	Část#: IEG1-1REC5-69-500-31-V	Výrobci: Sensata Technologies, Airpax	Dotaz
	Popis: CIR BRKR MAG-HYDR		
	Část#: IEG1-1REG4-51-20.0-A-01-V	Výrobci: Sensata Technologies, Airpax	Dotaz
	Popis: CIR BRKR MAG-HYDR		

Související klíčová slova pro IEG1-25715-1

Sensata Technologies, Airpax IEG1-25715-1.	IEG1-25715-1 distributor	IEG1-25715-1 dodavatel	IEG1-25715-1 Cena
IEG1-25715-1 Stáhnout datasheet.	IEG1-25715-1 Datasheet.	IEG1-25715-1 Stock.	koupit IEG1-25715-1.
Sensata Technologies, Airpax IEG1-25715-1.	Sensata Technologies/Airpax IEG1-25715-1.		